

Dell Mobile Computing Station

Ethernet Switch Replacement

• K001029

• K001086



CUSTOM SOLUTION FOR DELL BY ERGOTRON

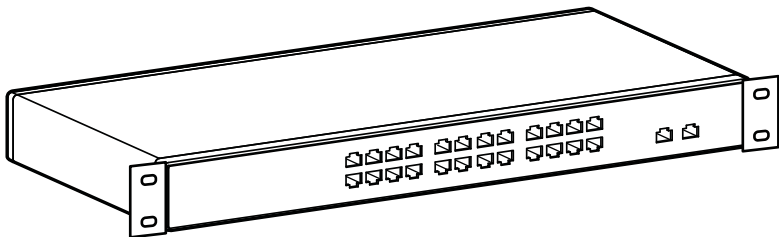

1	1	24	24	1	1	24	24
2	2	23	23	2	2	23	23
3	3	22	22	3	3	22	22
4	4	21	21	4	4	21	21
5	5	20	20	5	5	20	20
6	6	19	19	6	6	19	19
7	7	18	18	7	7	18	18
8	8	17	17	8	8	17	17
9	9	16	16	9	9	16	16
10	10	15	15	10	10	15	15
11	11	14	14	11	11	14	14
12	12	13	13	12	12	13	13

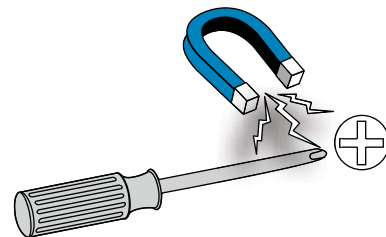
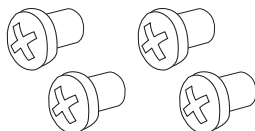

1a

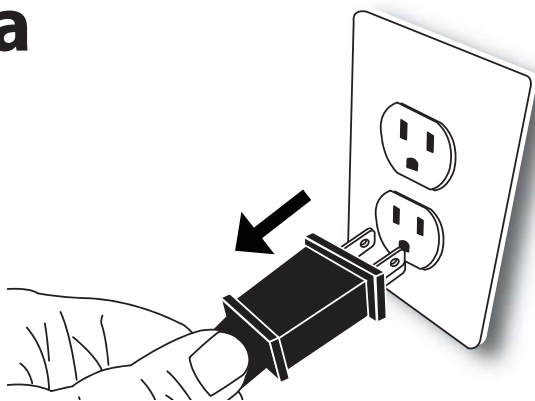

b

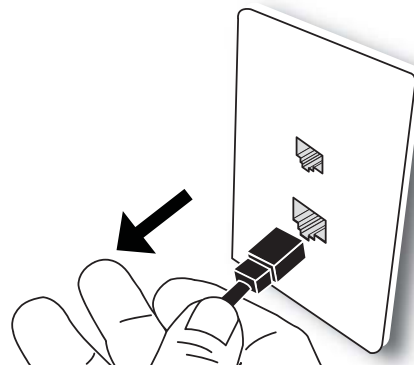

2a

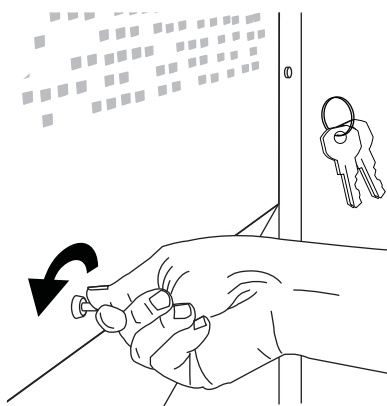

b

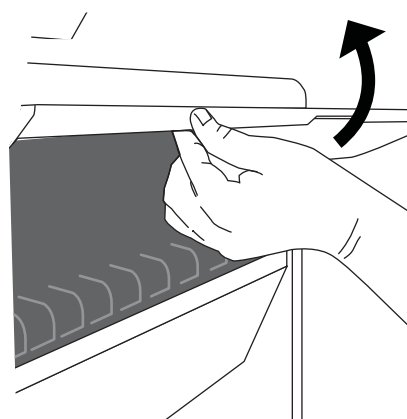

c

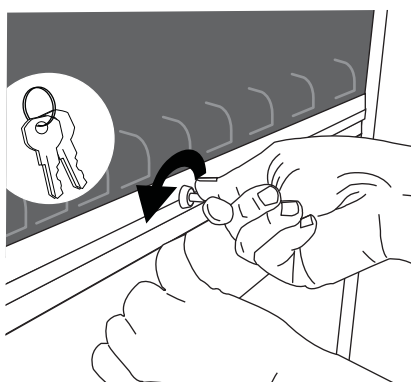

d

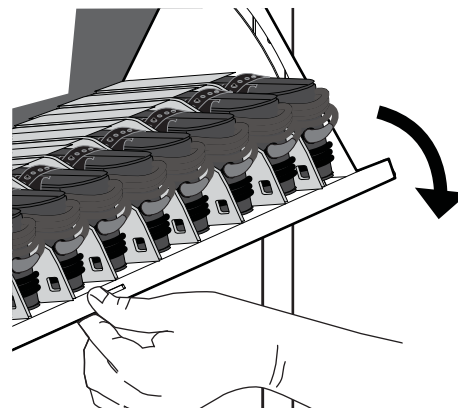

Dell Mobile Computing Station

3a

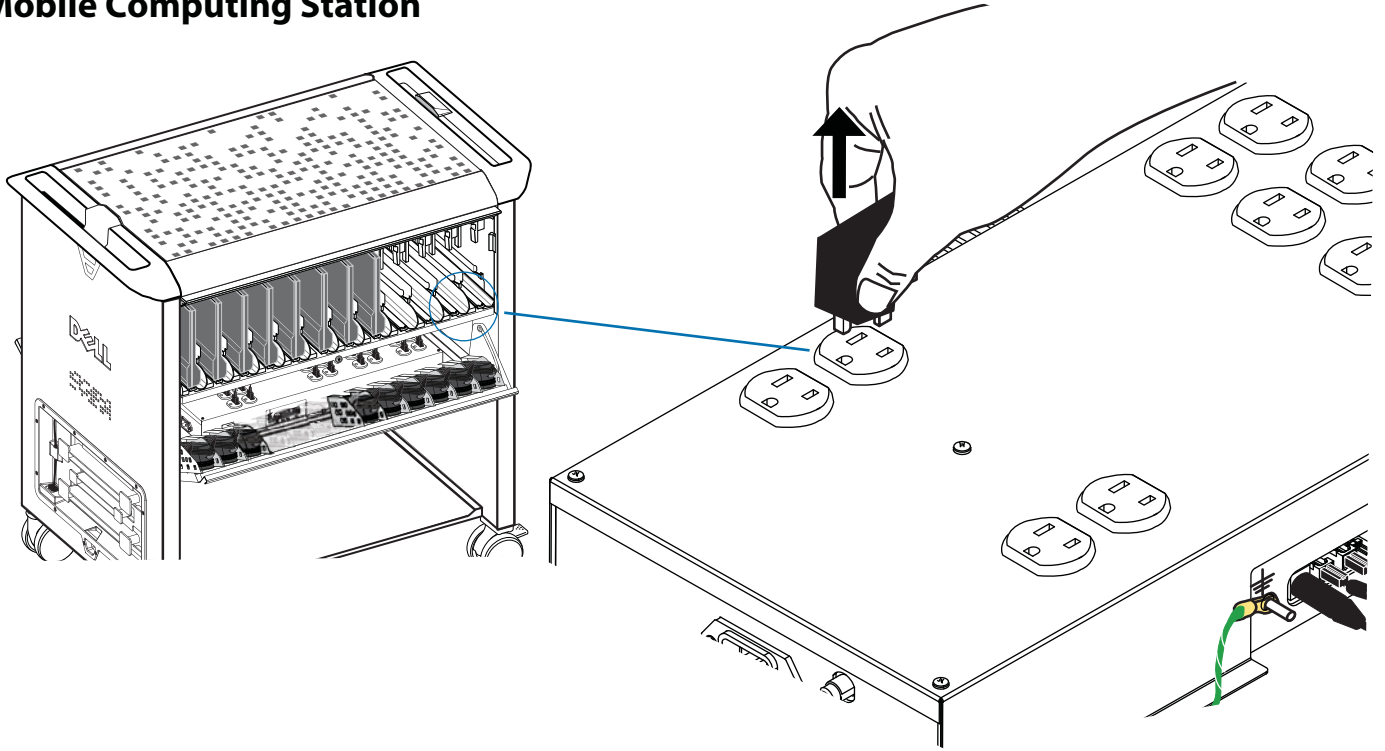

b

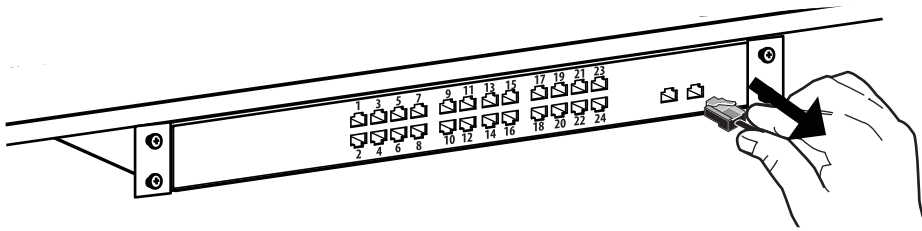

c 24x

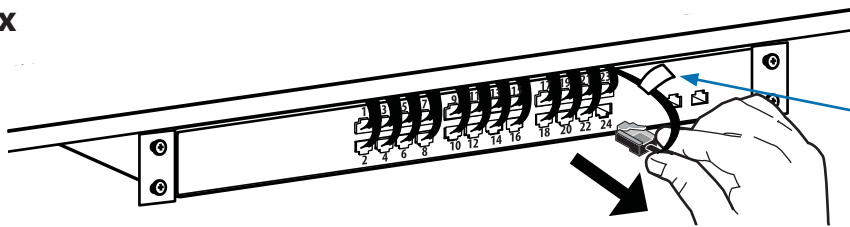

1	1	24	24	1	1	24	24
2	2	23	23	2	2	23	23
3	3	22	22	3	3	22	22
4	4	21	21	4	4	21	21
5	5	20	20	5	5	20	20
6	6	19	19	6	6	19	19
7	7	18	18	7	7	18	18
8	8	17	17	8	8	17	17
9	9	16	16	9	9	16	16
10	10	15	15	10	10	15	15
11	11	14	14	11	11	14	14
12	12	13	13	12	12	13	13

d 4x

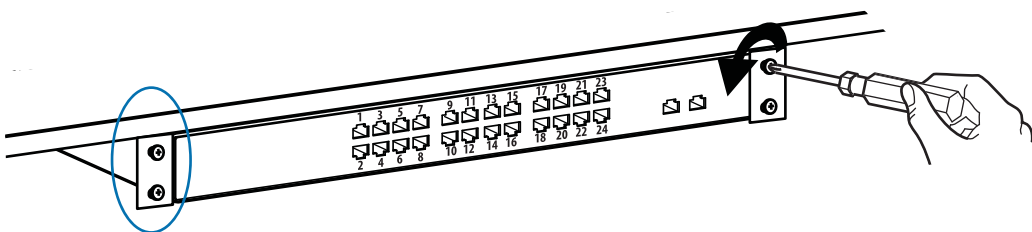

e

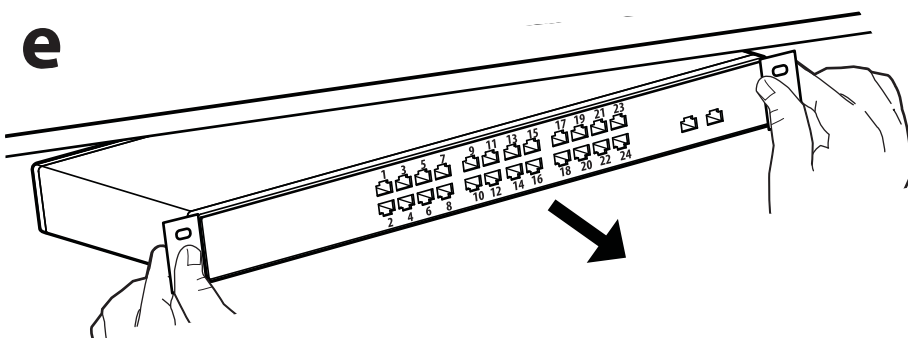

f

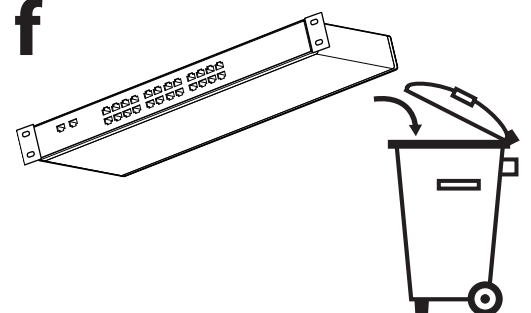

Dell Mobile Computing Station

4a

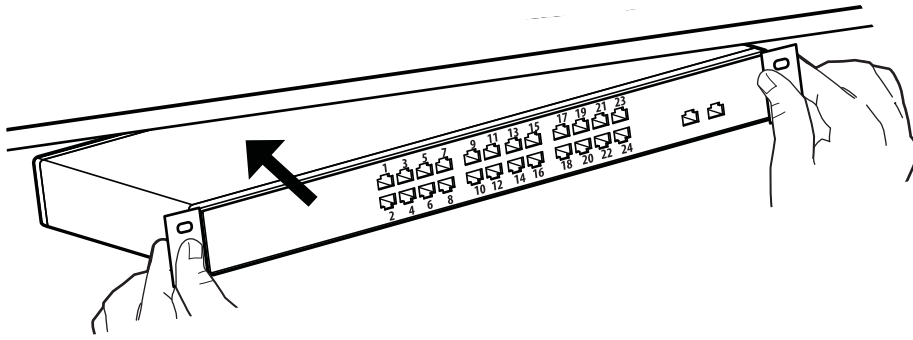

b

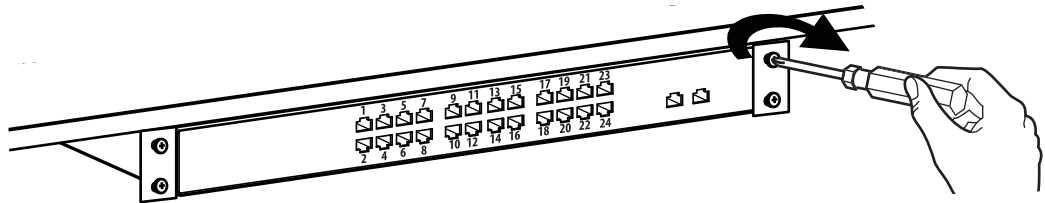
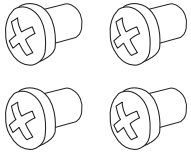

c 2x

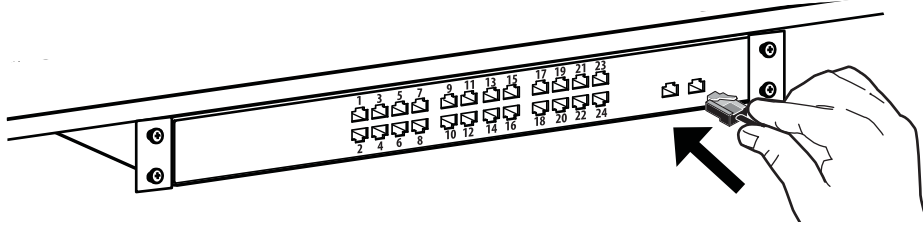

d 24x

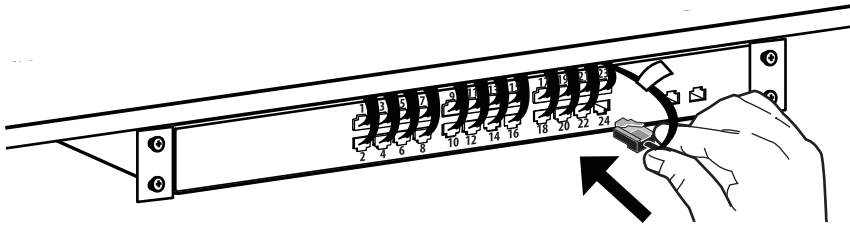

e

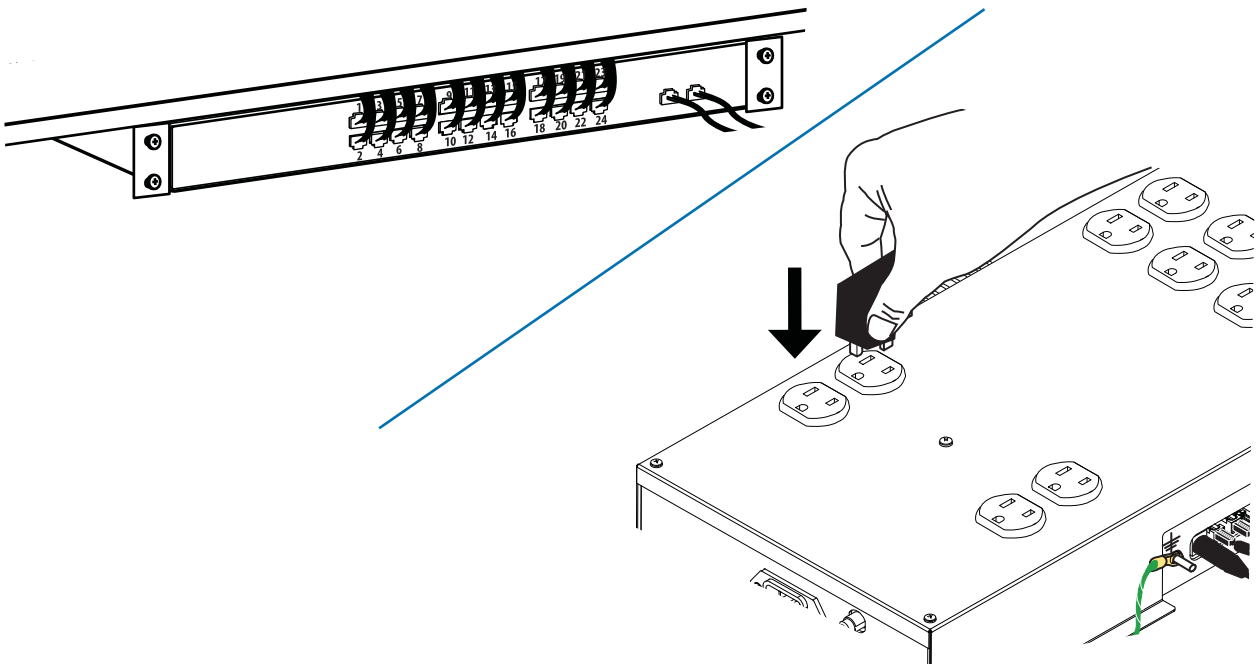

Dell Mobile Computing Station

5a

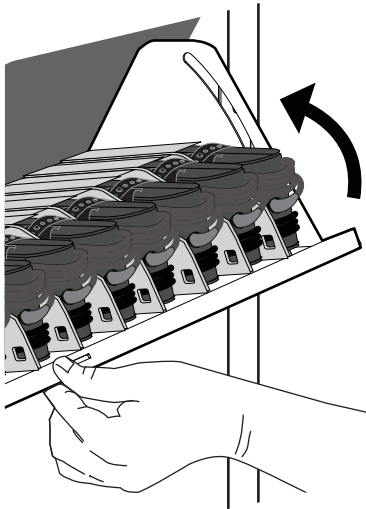

b

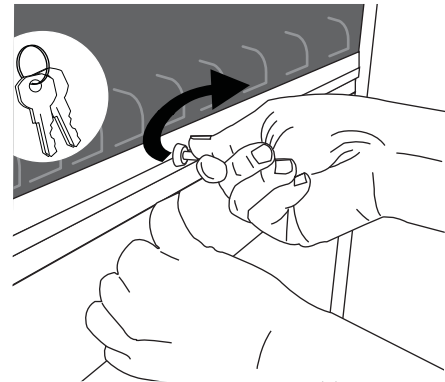

c

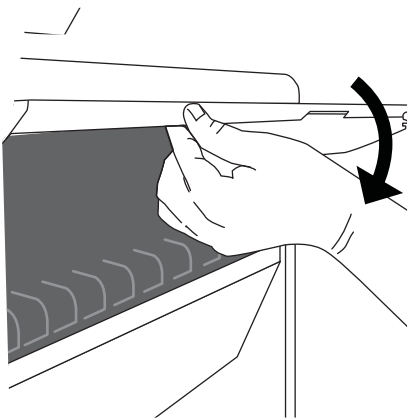

d

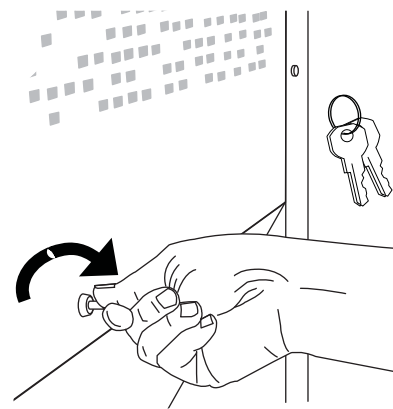

e

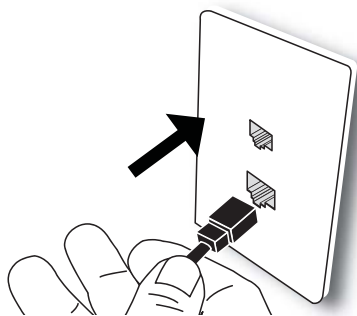

f

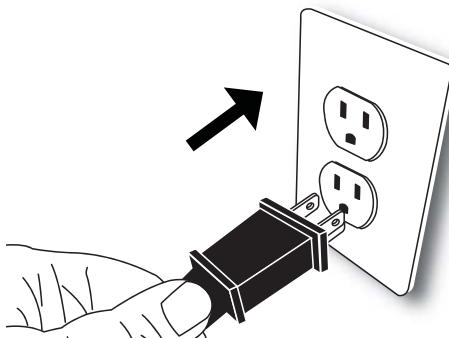

**CUSTOM SOLUTION FOR DELL BY ERGOTRON
FOR SERVICE VISIT www.ergotron.com/Dell**



© 2010 Ergotron, Inc.
All rights reserved.

While Ergotron, Inc. makes every effort to provide accurate and complete information on the installation and use of its products, it will not be held liable for any editorial errors or omissions (including those made in the process of translation from English to another language), or for incidental, special or consequential damages of any nature resulting from furnishing this instruction and performance of equipment in connection with this instruction. Ergotron, Inc. reserves the right to make changes in the product design and/or product documentation without notification to its users. For the most current product information, or to know if this document is available in languages other than those herein, please contact Ergotron. No part of this publication may be reproduced, stored in a retrieval system, or transmitted in any form or by any means, electronic, mechanical, photocopying, recording or otherwise without the prior written consent of Ergotron, Inc., 1181 Trapp Road, Eagan, Minnesota, 55121, USA. Patents Pending and Patented U.S. & Foreign. Ergotron is a registered trademark of Ergotron, Inc.